

thoenes[®]

Company portrait



future**TEX**
Partner



energy
saxony

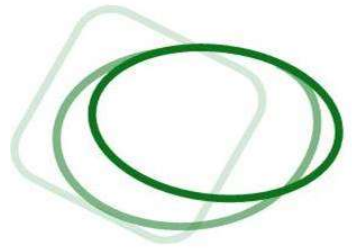

...we are!

thoenes[®]



- Tradition since 1878
- Quality as claim
- Products with sense
- Innovation as engine
- Customers as partners



<https://thoenes-solutions.com/en>

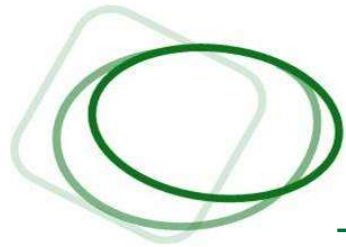

We stand for...

- Tradition 145 years oriented towards customer requirements
- Innovation New application and technological solutions
- Quality DIN EN ISO 9001:2015
DIN EN ISO 14001:2015
DIN EN ISO 45001:2018
- Flexibility Over 1000 customers all over Europe
- Service Customer service with professional and technical advice
- Continuity

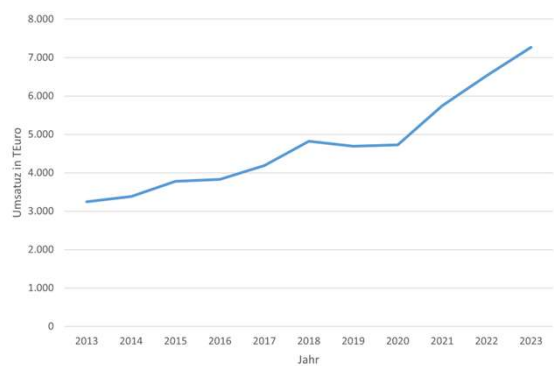

thoenes®

ZERTIFIKAT ◆ CERTIFICATE ◆ CERTIFICADO ◆ CERTIFICAT ◆ CERTIFIKAT ◆ 認證證書 ◆ CERTIFICATE ◆ ZERTIFIKAT



CERTIFICATE

The Certification Body
of TÜV SÜD Management Service GmbH
certifies that

thoenes®
Dichtungstechnik GmbH
Zeppelinstr. 1
01665 Klipphausen
Germany

has established and applies
a Quality Management System for

Manufacturing, development and distribution of
sealing, filtration and lightweight solutions.

An audit was performed, Order No. 707103734.
Proof has been furnished that the requirements
according to

ISO 9001:2015

are fulfilled.

The certificate is valid from 2020-07-01 until 2023-06-30.

Certificate Registration No.: 12 100 58500 TMS.

E. Kott
Product Compliance Management
Munich, 2020-05-26



TÜV SÜD Management Service GmbH • Zertifikatsstelle • Riederstrasse 17 • 80339 München • Germany
www.tuv-sud.de/certificate-validity-check

TUV®

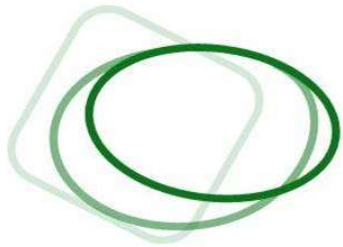

thoenes® Quality

thoenes®

The three management systems - QM - UM - AM - are implemented as an integrated management system in the company policy. The goal is to maintain the following permanently:

Products:

We want to make a contribution to environmental protection with our technologies, in the development of which we attach great importance to sustainability in terms of energy efficiency and resource conservation.

Employees:

Every employee is responsible for the quality of his or her work results. We promote and reward all ideas and measures of our employees that improve quality, work safety and reduce the environmental impact of our products and processes.

Environment:

We meet the increasing demands of our customers and the market through future-oriented, quality-enhancing and environmentally friendly processes.

Quality:

We owe our business success to our products, a high flexibility, reliability of our employees and delivery reliability primarily to the high quality standard in our company. We are constantly developing our own quality capability in order to meet the high demands of our customers.

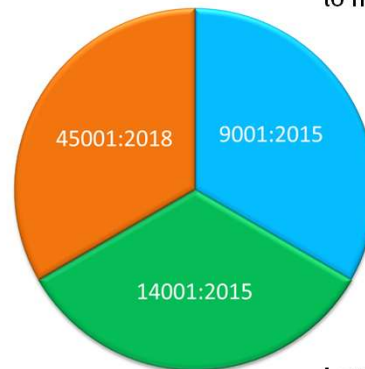

Customers:

The primary objective is to fully meet customer requirements and to adapt operations to changing customer requirements, quality criteria and new processes. By maintaining a close partnership with our customers, we can contribute our knowledge and experience to our mutual benefit.

Laws:

We undertake to comply with existing environmental and occupational health and safety laws and regulations. Plants, products and disposal are monitored on our own responsibility. Anything identified as necessary is tackled on our own initiative even without legal obligation or official requirements..

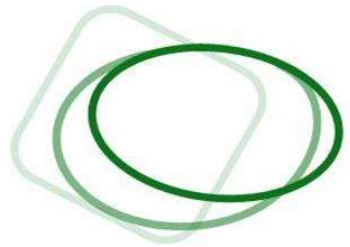

Visit our new website

thoenes[®]

Since 30 April 2019, our new website has been online at <https://thoenes-solutions.com/en>. An intensive and exhausting cooperation preceded this start. Everyone who was involved in the development process got to know our company and what we work for in a completely new way during this time and understood what opportunities and challenges lie ahead of us.

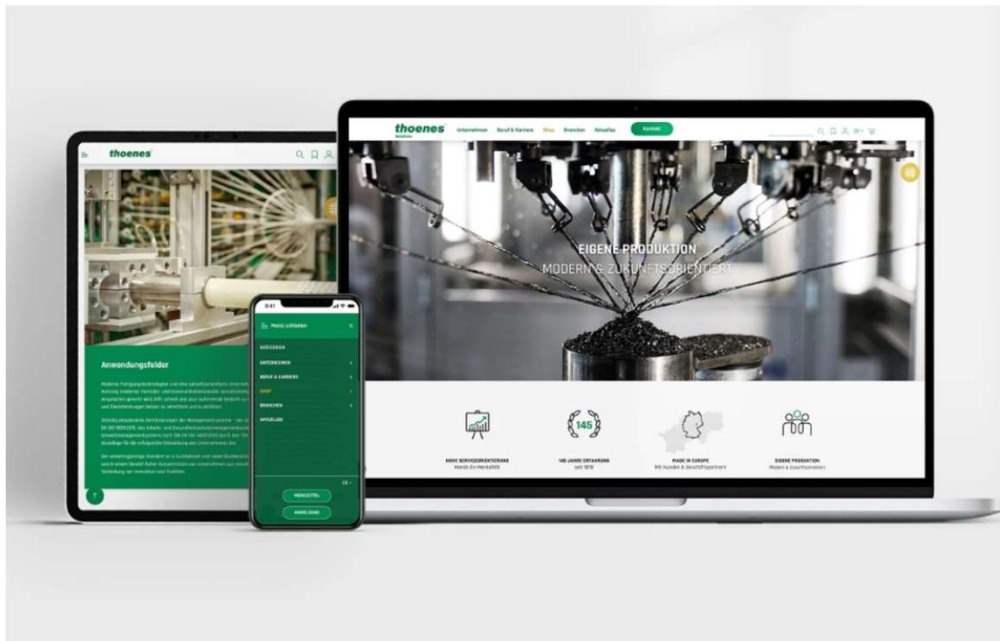

Our new shop offers a variety of cords and stuffing box packings as well as flat gaskets from our product range, in addition to the special tools that we have already bought a lot and loved. The processing of incoming inquiries and orders is even faster than before. A special feature of our new website is the possibility to communicate directly with our team, to ask questions and to get competent advice.

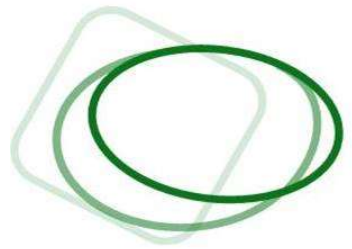

Products

thoenes[®]

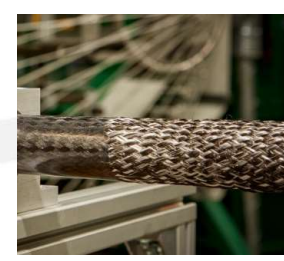
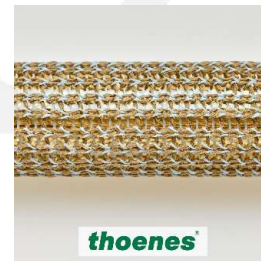

Sealing solutions



Filtration solutions



Lightweight solutions

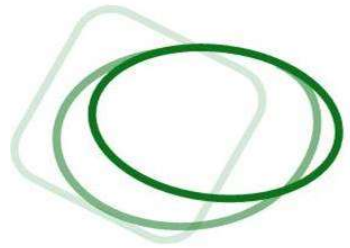

Sealing Solutions

Sealing- and Insulating cords

thoenes[®]

- **Braiding variants**

- Round
- Rectangular
- Quadratic (2-, 3- und 4-diagonal)

- **Diameter/ Edge lengths**

- 1 mm to 70 mm

- **Materials**

- Glass fibre (Standard- or silane coating)
- Aramid fibre
- Carbon fibre
- Basalt fibre
- Stainless steel fibre
- Wire (copper, stainless steel, brass) - from 0.1 mm
- Synthetic fibres (polyester, polyamide,...)
- Impregnated (PTFE, vermiculite,...) or graphitized



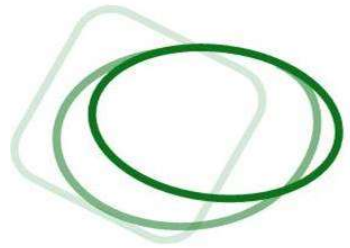

Packing geometry

thoenes[®]

Round braid



2 - lane / 2 - diagonal



3 - lane / 3 - diagonal



4 - lane / 4 - diagonal

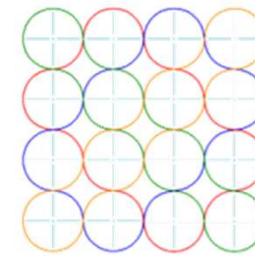
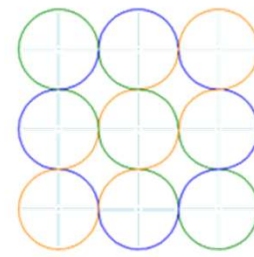
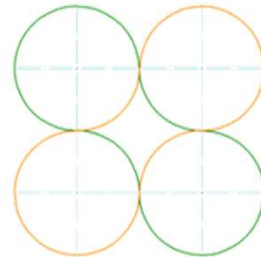
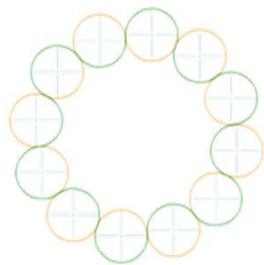

- Material 1
- Material 2
- Material 3
- Material 4

Each braid can be reinforced with axial **standing threads** (centre and corner inlets).

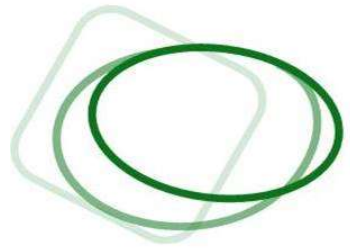

Static applications

thoenes[®]



- For oven, boiler and chimney doors
- Heating and heating furnaces
- Heat exchanger
- And many more static applications

Individual, customer-specific braiding solutions.



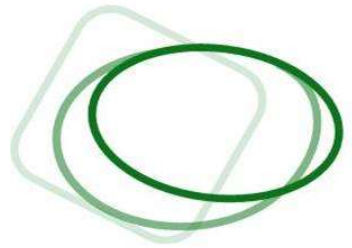

Sealing Solutions Gland Packings

thoenes[®]



For the most diverse forms of pumps, agitators, fittings, ...

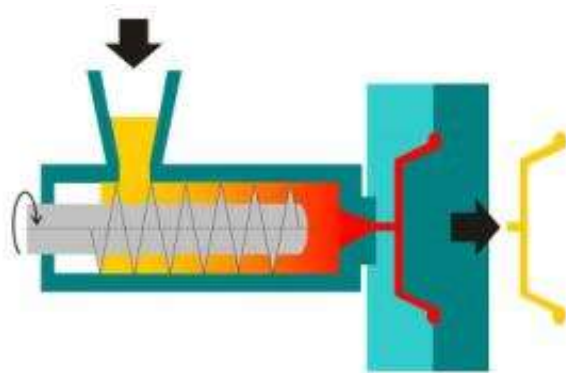

© 2010 Thoenes. Alle Rechte vorbehalten. Alle Rechte vorbehalten. Alle Rechte vorbehalten.



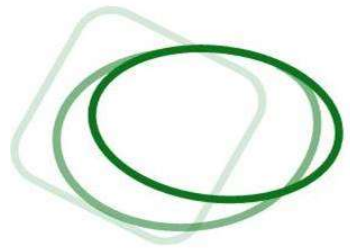

Sealing Solutions Special tools

thoenes[®]



...for the wear-free removal of old and professional cutting of new stuffing box packings.

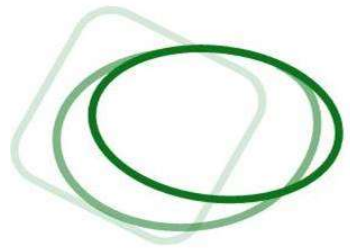

Sealing Solutions

Flat gaskets

thoenes[®]

Flat gaskets are used for flange connections in the most diverse industries.



Flat gasket material

■ max. temperature in °C ■ max. pressure in bar

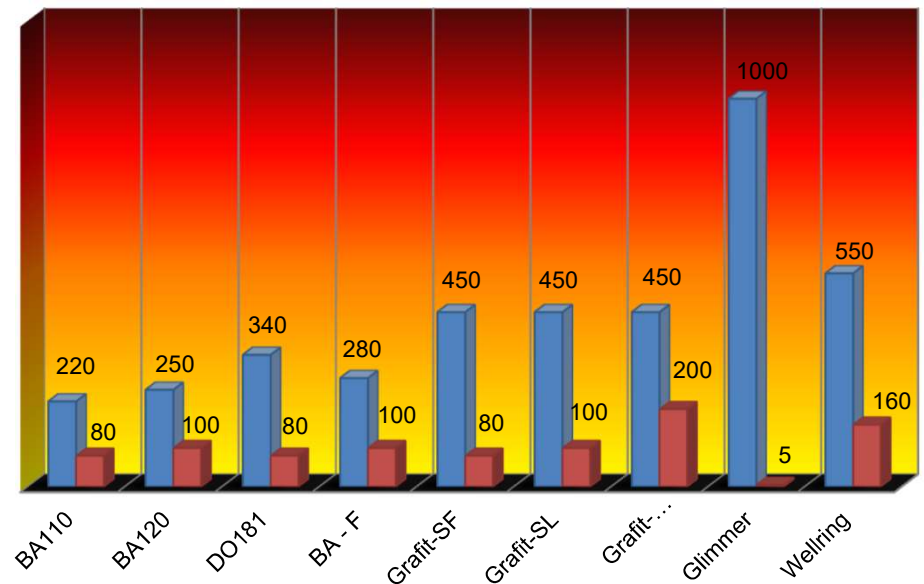

Unsere Materialien decken den Großteil der Anforderungen ab, die in modernen Anlagen gefordert sind.

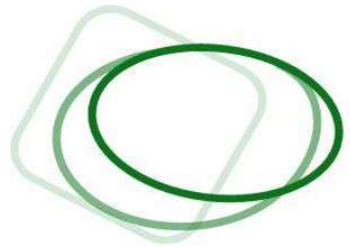

On-site support ...for flat gaskets and packings

thoenes[®]

...and competent advice

- for the case of operation,
- in the preparation and execution of tests with pressure-sensitive special films,
- joint development of solution-oriented proposals,
- and instruction as well as information of employees and technicians during assembly.



Your contact person:
Mr. Carl Wagner

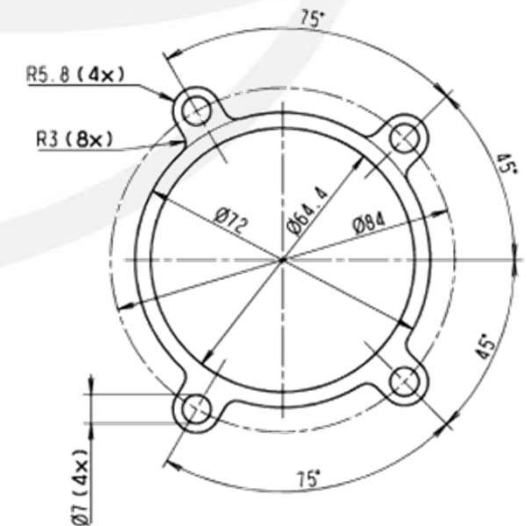

E-Mail: verkauf@thoenes-solutions.com
phone.: +49 35204 392825



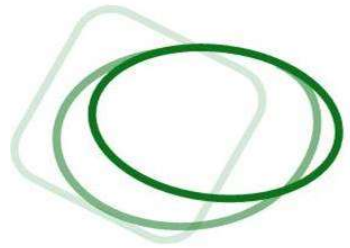

Filtration solutions **Filter and silencer**

thoenes[®]

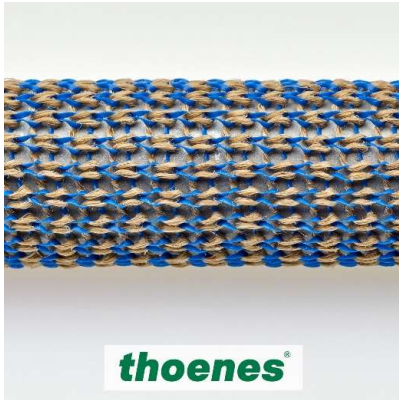

- PP, PA, PE
- Single or multi-threaded
- Reduction of compressed air noise
- Use for the filtration of liquids and gases
- Thermal cleaning up to 200°C possible



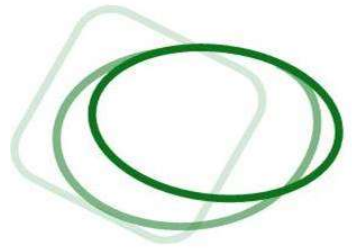

Lightweight solutions

thoenes[®]



Automated braiding
Defined handling

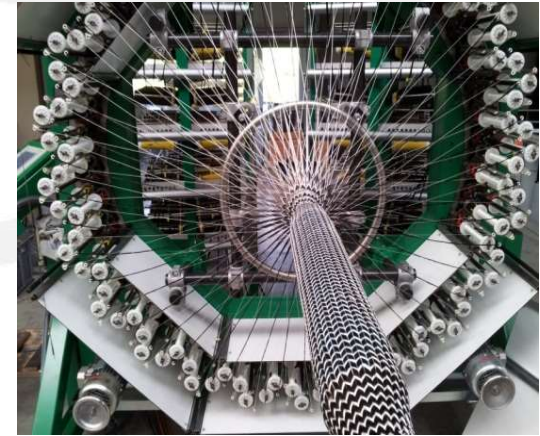

Precise manufacturing

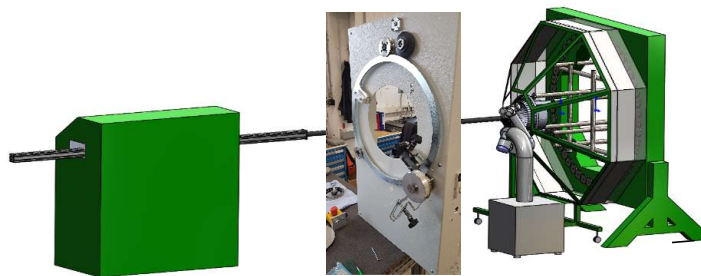

Functionalisation
Profile production

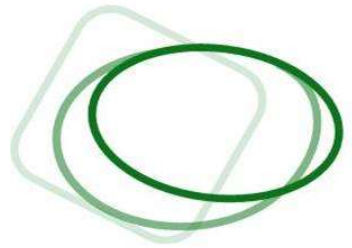

Lightweight solutions

Lightweight rolls

thoenes[®]

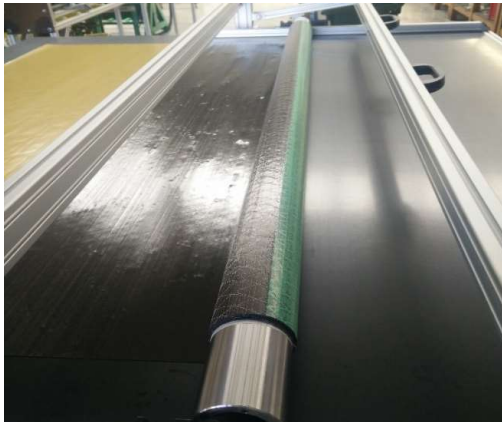

**Combination of glass
and carbon fibers**

**Processing of high
stiffness carbon fibers**



**Production of individual
dimensions**

**Load-suitable layer
structure**



Bonding of roller floors

Surface treatment

Equalisation

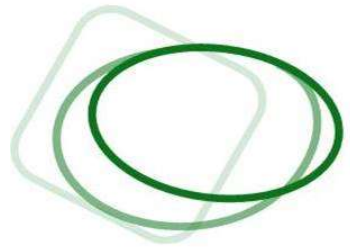

Lightweight solutions Lightweight rolls

thoenes[®]

CFRP deflection roller with ground surface

- Up to 70 % weight saving compared to steel
- Extremely smooth ground surface (up to Rz 0.4)
- High bending stiffness
- Customized dimensions
- CFK or GFK version
- Completely assembled version incl. studs and bearings



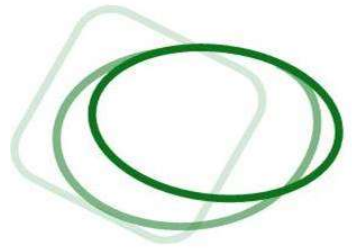

Research and Development

thoenes[®]



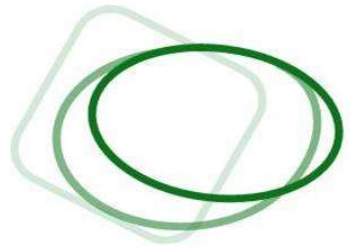

Research and Development – Future Orientation

thoenes[®]



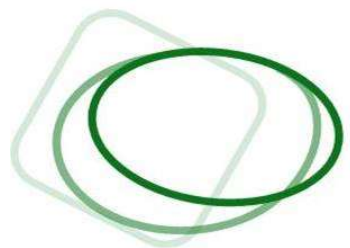

thoenes[®]



**Tight
with you!**

phone.: +49 35204 39 28 0
Fax: +49 35204 39 28 50
E-Mail: info@thoenes-solutions.com